

# ILIFE-A11

Robotic vacuum cleaner

## User Manual

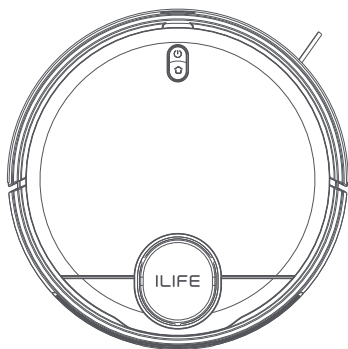

For more details, please  
visit [www.iliferobot.com](http://www.iliferobot.com)

**ILIFE**



Dear Customer,

Thank you for purchasing ILIFE A11 robotic vacuum cleaner!  
You've joined the millions of people who clean with robots - the smarter way to get it done.

Please take a few moments to read this manual and get acquainted with your robot, to get the best performance from your robot. If you have any problems with your robot please do not hesitate to contact our customer service or visit our website at [www.iliferobot.com](http://www.iliferobot.com) for more information.

Stay connected with us on Facebook and twitter to enjoy these exclusive benefits:

- Get support tailored to your specific robot, including answers to questions, maintenance tips, video demos, live chat and more.
- Get product updates and other valuable information among the first to find out about new robots, exclusive discounts and special promotions.

Connect with us right now at  
Facebook: [facebook.com/iliferobotics](https://facebook.com/iliferobotics)  
Twitter: [twitter.com/ILIFEROBOTUS](https://twitter.com/ILIFEROBOTUS)

Enjoy a thorough cleaning every day!  
Best regards,  
ILIFE Innovation

## ILIFE Customer Service



**1-800-631-9676** (Toll free for North America)  
Mon-Fri: 8:00 A.M. - 7:00 P.M. CST



[service\\_us\\_ca@iliferobot.com](mailto:service_us_ca@iliferobot.com)

## Table of Contents

<b>Safety Instruction</b> .....	3
<b>Product Composition</b> .....	5
List Of Accessories .....	5
Introduction Of Robot And Accessories .....	6
<b>How To Use</b> .....	10
Quick Start .....	10
Mode Selection .....	12
Current time .....	13
Water level adjustmen .....	13
Cleaning scheduling .....	14
Install 2 in 1 Water Tank .....	15
Light Indication .....	16
<b>APP Download</b> .....	17
<b>Maintance</b> .....	18
Dustbin .....	18
2-in-1 Water Tank .....	19
Rolling Brush & Side Brush .....	20
Boundry Sensor .....	21
<b>Troubleshooting</b> .....	22
<b>Product Specification</b> .....	25

## Safety Instructions

---

### Warnings

1. This robot should not be used by children under 8 years old or people with mentally challenged, unless they are under supervision. Do not let children sit on the robot or use it as a toy.
2. Attend to the robot promptly if an error occurs during cleaning. Before using the robot, remove all power cords and small objects on the floor. Roll up carpet tassels and make sure curtains and table cloth are not in contact with the floor.
3. If there are hanging steps or stairs, please test if the robot can detect them before use. If not, please set up barriers to avoid falling down, and make sure that the barriers cause no harm to people.
4. Follow the instructions in this user manual. Use factory authorized or recommended accessories only.
5. Make sure the voltage of the charging dock is compatible with the voltage of power supply.
6. Use the robot indoor and in a home environment only. Do not use it outdoor, or in commercial or industrial spaces.
7. Use factory authorized adaptor and charging dock only. Do not use non-rechargeable battery. Refer to "Product Specifications" section for details about battery standards.
8. Do not soak the robot in water and do not rinse the robot under the faucet.
9. Do not clean the robot with dripping wet cloth.
10. Do not use the robot on floors with ponding water.
11. Do not use the robot near fire or fragile objects.
12. Do not use the robot under extreme temperatures below  $-5^{\circ}\text{C}$  or above  $40^{\circ}\text{C}$ .
13. Do not make the cloth, humans hair, finger, or other parts of the body close to the open or the running mechanism of the robot.
14. Do not use the robot on floors with stones or paper to avoid being stuck.
15. Do not use the robot in areas with any flammables, such as gasoline, toner and so on. Or use the robot to clean any burning objects, like cigarettes, ashes or matches, or anything that may cause a fire.

## Safety Instructions

---

16. Do not use damaged charging dock.
17. Do not lift up the robot or the charging dock by the power cord, and keep the power cords away from heat and avoid it being trapped around doors, sharp edges or corners.
18. Damaged power cords must be repaired by manufacturer's repair service or certified technicians.
19. Install dustbin and filters properly before using the robot.
20. Do not use the robot in rooms where babies are sleeping.
21. Do not use damaged power cords or charging dock to recharge the robot. Do not use the robot if it's damaged by falling down, or soaking in water.
22. Turn off the power switch if the robot will not be used for a long time.
23. Turn off the power switch before cleaning or maintaining the robot.
24. Unplug power cords from the charging dock before cleaning or maintaining the robot.
25. Remove battery before discarding the robot.
26. Robot and battery are to be disposed of according to local safety regulations.
27. Do not cremate the robot to avoid the explosion.
28. Follow the instructions in this user manual. Manufacturer is not responsible for any damages caused by improper use.

**Note:**

This product could not be used by children, mentally challenged people or people lack of related experience and knowledge (Unless there people instruct or supervise them).

## Product Composition

### List of accessories

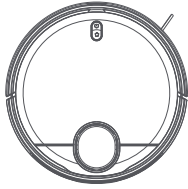

Main Body

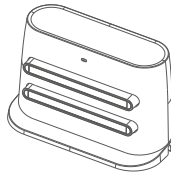

Charging Dock

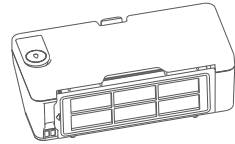

2-in-1 Water Tank

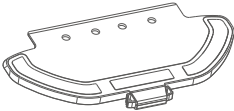

Duster Component

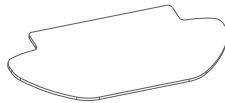

Mop Cloth

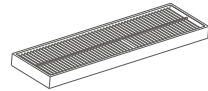

Filter

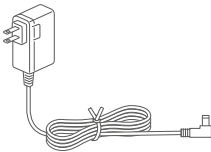

Power Adapter



Cleaning Tool

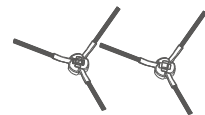

Extra Side Brush X2



User Manual



Remote Control



Rubber Brush

## Product Composition

### Introduction Of Robot And Accessories

#### Robot Anatomy

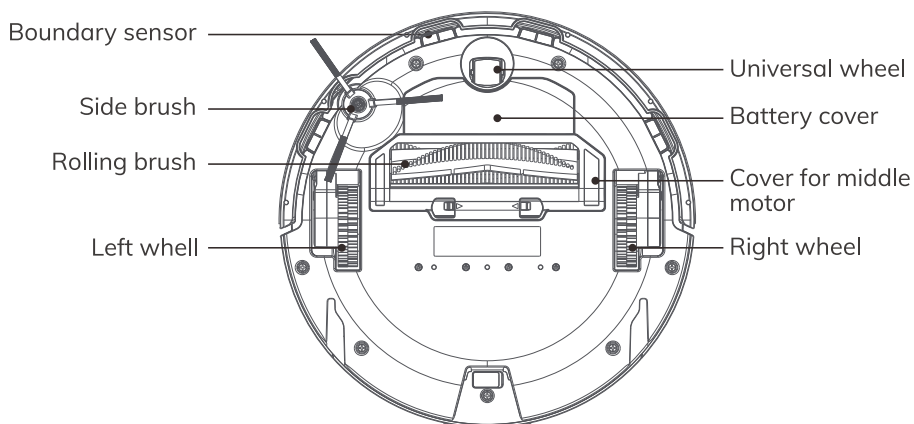
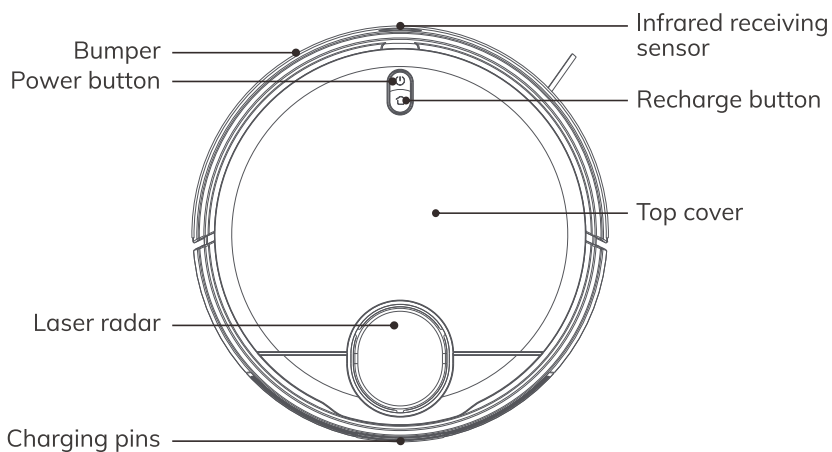



## Product Composition

---

### 2-in-1 Water Tank

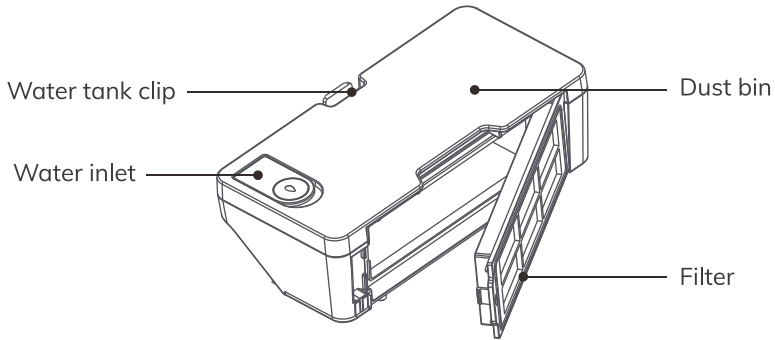

### Duster Component

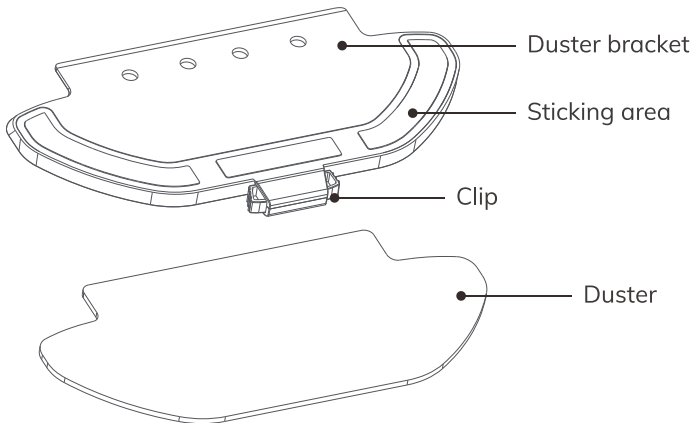

## Product Composition

---

### Dustbin Component

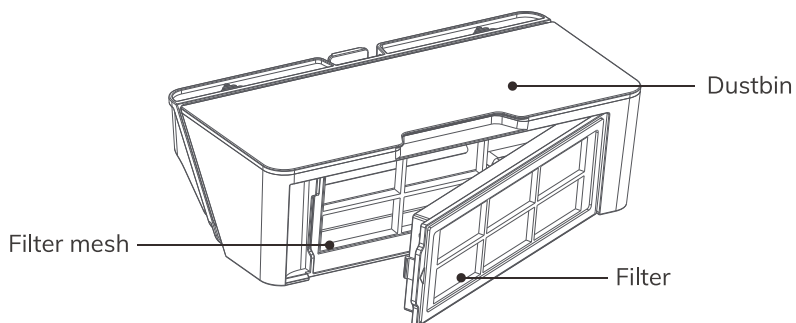

### Charging Dock

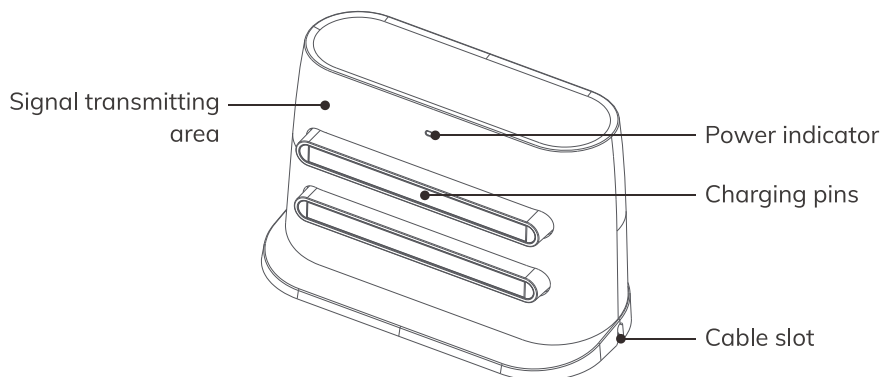

## Product Composition

---

### Remote Control

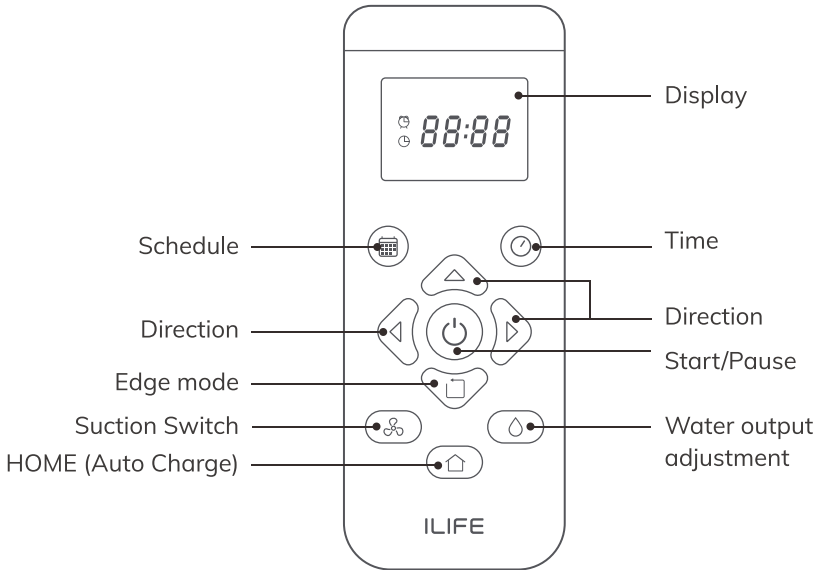

**Note:**

“▲” “◀” “▶” cannot be used during a cleaning cycle.

## How To Use

### Quick Start

#### Charging

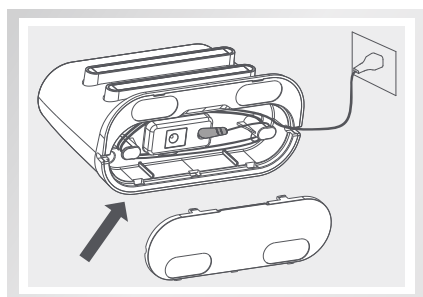

**1** Connect the power cord, and collect the redundant cable.

- Please put the redundant cable into the cable slot at the bottom of the charging dock, otherwise the cable may be dragged and disconnect power supply to the charging dock.

**3** Startup and charge.

- Long press  for 3s; the indicator light on the robot comes on, connect the robot to the charging dock for charging.
- In case of low battery, it is possible that the robot cannot start up or shut down. Please directly connect the robot to the charging dock.
- The robot will start up automatically after connection to the charging dock.
- The robot cannot shut down while it is connected to charging dock.

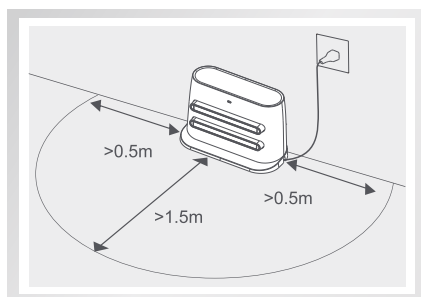

**2** Place the charging sock against a wall, and connect the power supply.

- Please ensure a space of at least 0.5m on both the left and right sides of the charging dock, and a space of at least 1.5m in front of it.
- Do not expose the charging dock to direct sunlight.

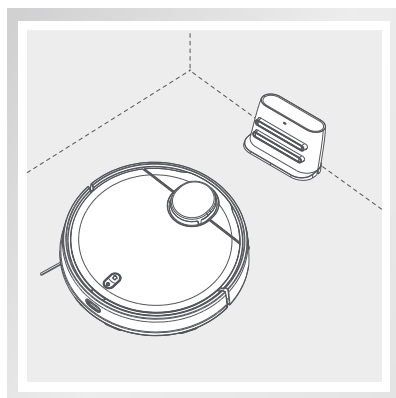

## How To Use

---

### Startup / shutdown

- The robot will start up automatically while it is being charged on the charging dock.
- The robot cannot shut down while it is being charged on the charging dock.
- Long press the Power Button ; the power indicator light comes on , and the robot enters the power-on state ; after startup,a prompt tone will be heard.
- When the robot is stationary,long press the Power Button to shut it down; there will be a voice prompt indicating shutdown.



### Cleaning

- In power-on state,short press the power button;the voice prompt will be heard.
- In power-on state,short press the Recharge Button ; the voice prompt will be heard.
- Enter the device home page via the App ;click the "Start"button to start cleaning. The voice prompt will be heard.
- Enter the device home page via the App ;click the "Recharge"button to start recharging.The voice prompt will be heard.

**Note:**

In case of low battery,the cleaning function cannot be enabled.

### Pause

When the robot is in operation, press any button to pause; press  to continue cleaning; press  to return to the charging dock and end the current cleaning task.



### Recharging

- When the robot finishes cleaning,the voice prompt"Cleaning is finished.Enter the recharge mode"will be heard.The robot will get recharged automatically.
- In case of low battery during cleaning,the robot will get recharged automatically; after it gets fully charged,it continues where it stops previously.
- The robot shuts down automatically if the battery is exhausted,you can manually put back the robot to the charging dock for charging.Please ensure that the charging pins are in good contact.

## How To Use

### Mode selection

#### 1 Path mode

The most frequently used cleaning mode. Press  on the main body or  remote control. Robot plans a path and cleans along a zigzag pattern. During cleaning, robot detects and cleans areas that have been missed.

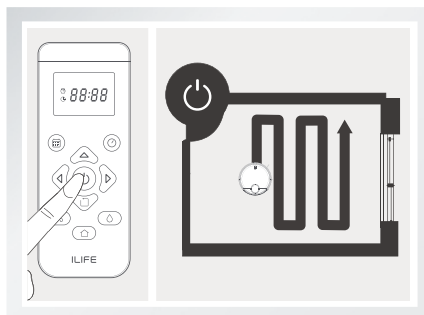

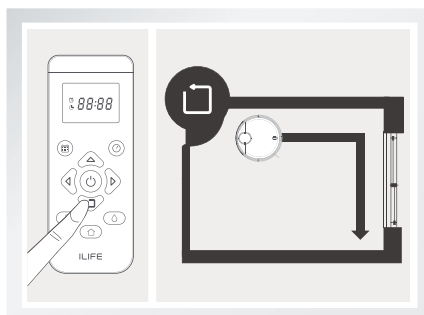

#### 2 Edge mode

Press the button  once to enter edge cleaning when robot is in selected mode.



#### 3 MAX mode

It is suitable for the environment where the whole ground is dirty and with more dust. Press the "" button of the remote control to increase the suction of the robot. Press the "" button again to switch to normal suction.

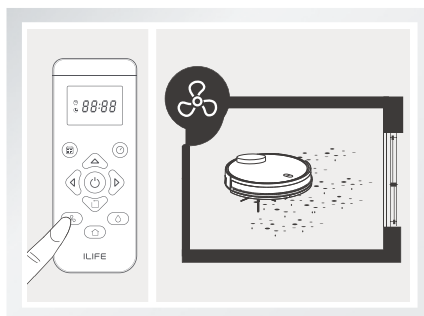

## How To Use

### 4 Auto charge mode

The robot can sense lower power during the cleaning process and automatically activate Self-charge Mode and search for the charging dock.





**Note:**

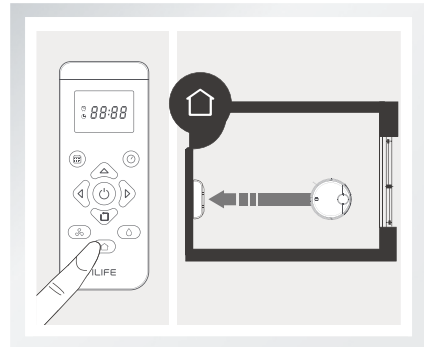

You can also use the button  on the remote control to command the robot to activate the mode.



### Current time

- 1 Long press the "  "button. The first 2 digits, indicating the hour, will start blinking.
- 2 Use the up and down direction buttons to set the current to set the current time. Use the left and right buttons to switch from hours to minutes and repeat the before step.
- 3 Press the "  "button again to save the settings.

### Water level adjustment

- 1  Press once, the screen shows mode 1, which also means water level mode 1.
- 2  Press twice, the screen shows mode 2, which also means water level mode 2.
- 3  Press third times, the screen shows mode 3, which also means water level mode 3.

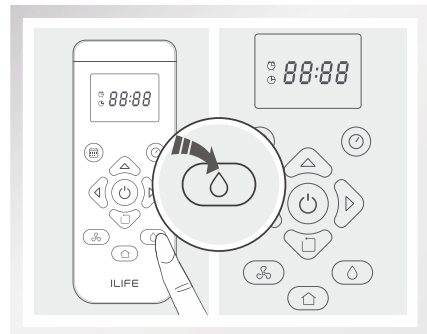

## How To Use

### Cleaning scheduling

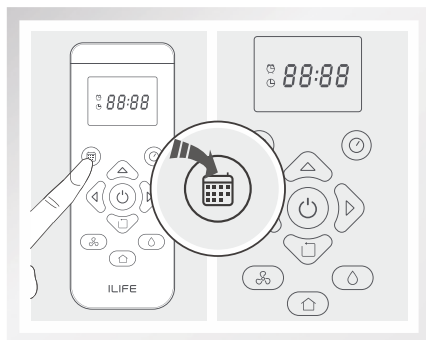

- 1 Long press the  button. The first 2 digits, indicating the hour, will start blinking.

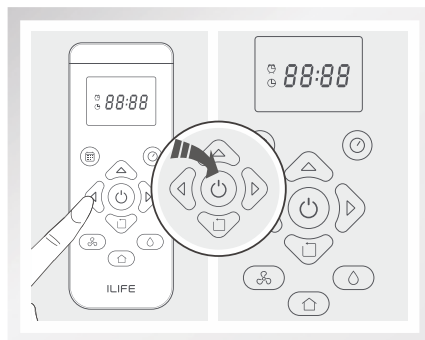

- 2 Use the up and down direction buttons to set the current time. Use the left and right buttons to switch from hours to minutes and repeat the before step.

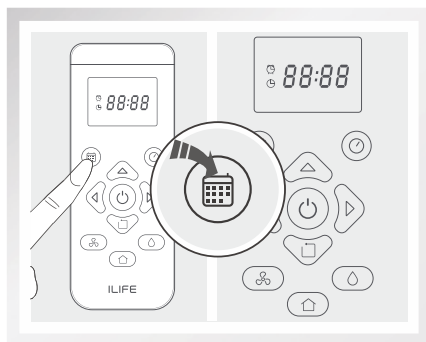

- 3 Press the  button again to save the settings.

#### Note:

1. To cancel the scheduled cleaning: Set the clock on the remote control to 00: 00 am and save it. Switch the robot off for 1 minute and switch it on again.
2. The robot will emit a beep to indicate all settings have been saved.
3. When the remote control's batteries are replaced, the clock and schedule times must be set again.



## How To Use

### Install 2 in 1 Water Tank

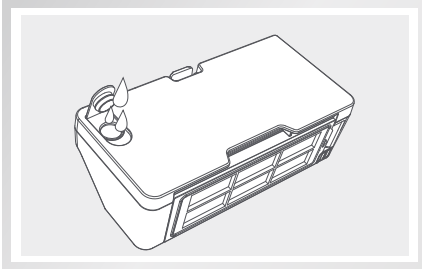

- Open the rubber cover of the water tank; fill the water tank with water; then close the rubber cover.

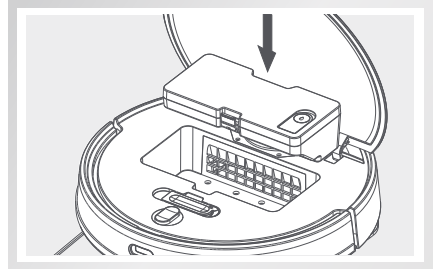

- Install the water tank into the robot in the indicated direction; confirm that the clip is properly installed.

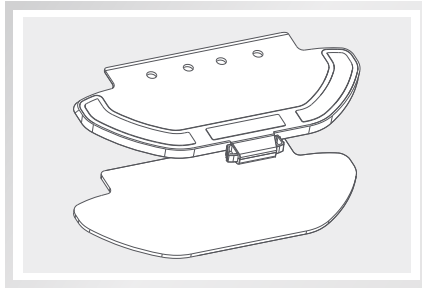

- Attach the duster into the duster bracket, and stick the duster to the Velcro.

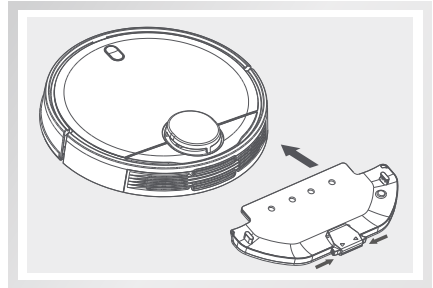

- Manually press the clips on both sides of the duster bracket, and push the duster bracket to the bottom of the robot in the indicated direction.

## How To Use

---

### Light Indication

- When the button light on the robot is off,the robot is in "power-off/sleep"state.
- When the blue button light on the robot blinks continuously,the robot is in "network configuration"state.
- When the blue button light on the robot flashes in a brathing manner,the robot is in "start / upgrade"state.
- When the blue button light on the robot remains on,the robot is in " idle / standby / cleaning / pause " state.
- When the yellow button light on the robot continuously blinks slowly,the robot is in "recharge" state.
- When the yellow button light on the robot flashes in a breathing manner, the robot is in"charging"state.
- When the red button light on the robot continuously blinks fast,the robot is in "fault / troubleshooting" state.
- When the blue button light on the charging dock comes on,the charging dock is in power-on working state.

## APP Download

---

Scan BELOW CODE,OR SEARCH " ILIFE VAC" on App store to download the Application



ILIFE VAC APP

## Maintenance

### Dustbin

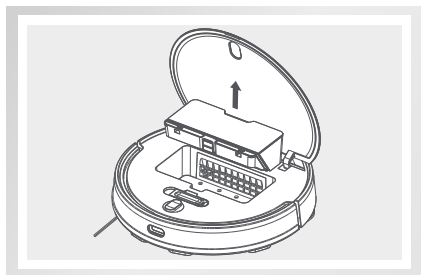

- Open the top cover to take out the dustbin, as shown in the figure.

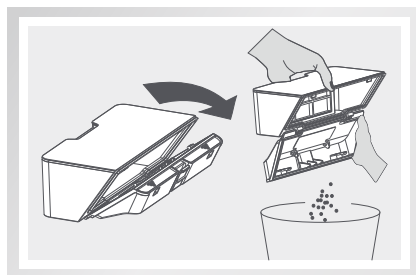

- Open the filter; take it out and empty it.

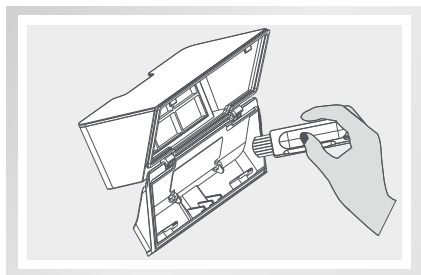

- Use the cleaning brush to clean the dustbin, and put back the filter.

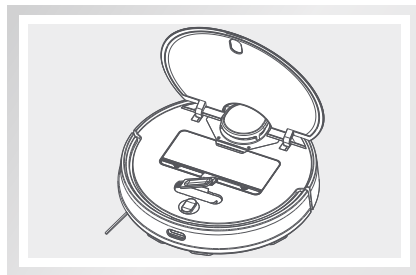

- Reinstall the dustbin and the cleaning brush, close the top cover.

- Follow the figure to remove the filter and clean it.

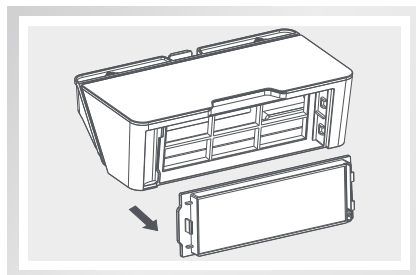

## Maintenance

### 2 in 1 Water Tank

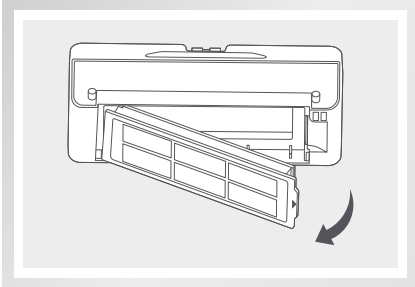

- Remove the filter of the 2-in-1 water tank and dust bin.

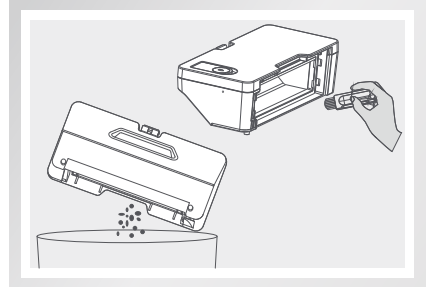

- Empty the trash, and clean the dust bin with cleaning brush, then put the filter back to the dust bin.

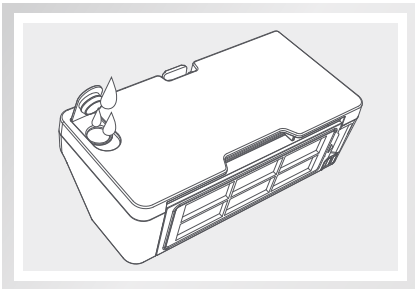

- Open the water tank cover, fill the water tank, and fasten the rubber cover.

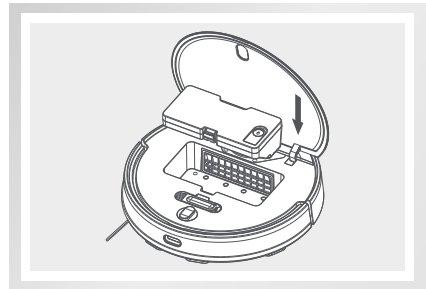

- Put the 2-in-1 water tank and dust bin back to robot vacuum cleaner.

## Maintenance

### Rolling Brush & Side Brush

#### Rolling Brush

- Turn over the lower clip to remove the cover for the middle motor;
- Take out the rolling brush and clean the bearing;
- Clean the rolling brush;
- Reinstall the rolling brush and fasten the clip of the cover.

**Note:**

Replace the rolling brush every 6-12 months to ensure the cleaning effect.

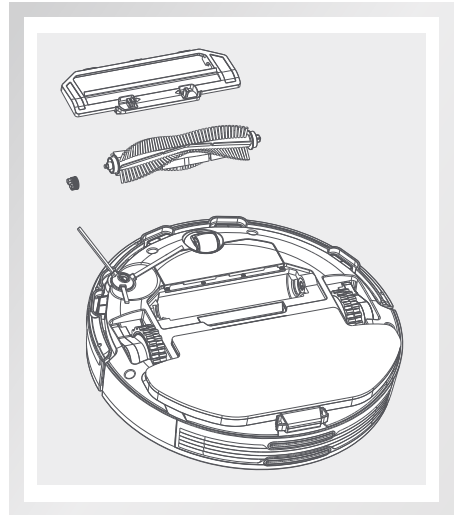

#### Side Brush

- Remove and clean the side brush regularly.

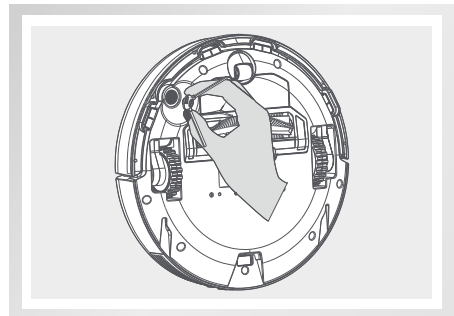

## Maintenance

---

### Boundary Sensor

- Clean the boundary sensor with soft cloth regularly.

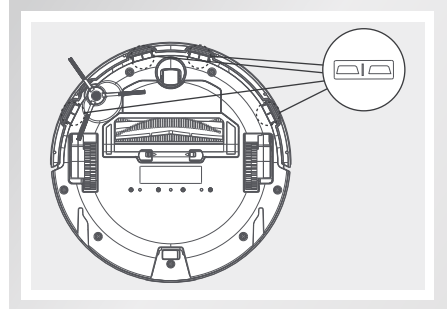

**Note:**

1. Replace the filter every three months as it is not washable;
2. Clean the filter with cleaning brush regularly to avoid blockage;
3. Replace the side brush every three months to ensure the cleaning effect.

## Troubleshooting

---

Fault prompt	Solution
Please confirm that the laser radar is not blocked.	Check or clear foreign objects around the laser radar, or move the robot to a new position and restart it.
Please wipe the boundary sensor and move the robot to a new position for restart.	Wipe the boundary sensor and retry ( for the sensor position, please consult the Instruction Manual ).
Please check and clear up foreign objects on the collision sensor.	Press the collision strip, clear foreign objects and restart.



## Troubleshooting

Problem	Solution
Power-on failure	<ul style="list-style-type: none"> <li>• The battery level is too low; connect the robot to the charging dock for charging.</li> <li>• The ambient temperature is too low (&lt;-5°C) or too high (&gt;40°C).</li> </ul>
Fail to start cleaning	<ul style="list-style-type: none"> <li>• The battery level is too low; connect the robot to the charging dock for charging.</li> </ul>
Recharging failure	<ul style="list-style-type: none"> <li>• There are too many obstacles near the charging dock; place the charging dock in an area free of obstacles.</li> <li>• The robot is too distant from the charging dock; place the robot near the charging dock and retry.</li> </ul>
Abnormal actions	<ul style="list-style-type: none"> <li>• Shut down and restart the robot.</li> </ul>
Abnormal sound during cleaning	<ul style="list-style-type: none"> <li>• The rolling brush, side brush or left / right wheel may be entangled with foreign objects; stop the robot and clear them up.</li> </ul>
Degradation of cleaning capacity or dust come-off	<ul style="list-style-type: none"> <li>• The dustbin is full; clear up the dustbin.</li> <li>• The filter is blocked; clear it up.</li> <li>• The rolling brush is entangled with foreign objects; clear up the main brush.</li> </ul>
Fail to connect to Wi-Fi	<ul style="list-style-type: none"> <li>• Wi-Fi signal is weak; ensure that the robot is in an area with good Wi-Fi signal.</li> <li>• Wi-Fi connection is abnormal; reset Wi-Fi and download the latest App, then try again.</li> </ul>

## Troubleshooting

---

Problem	Solution
Resume cleaning failure	<ul style="list-style-type: none"><li>• Confirm that the robot is not in DND mode since it will not continue cleaning in this mode. The robot will not continue cleaning when it is manually brought to the charging dock.</li></ul>
Charging failure	<ul style="list-style-type: none"><li>• Ensure that there is sufficient space around the charging dock, and that the surfaces of the electrodes are free from dust and coverage.</li></ul>
Fail to do scheduled cleaning	<ul style="list-style-type: none"><li>• Confirm that the device has been connected to the network; otherwise synchronization failure may result and timed cleaning tasks won't be performed.</li></ul>
The robot is always in off-line state	<ul style="list-style-type: none"><li>• Confirm that the device has been successfully connected to the network and it is always in the range covered by Wi-Fi signal.</li></ul>
Fail to pair the mobile phone with the device	<ul style="list-style-type: none"><li>• Ensure that the charging dock and the robot are in the area with good Wi-Fi signal; reset Wi-Fi according to the steps described in the Instruction Manual; then pair again.</li></ul>

## Product Specification

---

Classification	Item	Detail
Mechanical specifications	Diameter	350mm
	Height	94.5mm
	Weight	3.5kg
Electrical specifications	Power	40 W
	Battery type	5200mAh
	Charging type	Auto charging
Cleaning specifications	Cleaning mode	Spot, Edge, MAX, Daily schedule
	Charging time	≤180mins
	Cleaning time	≥100mins
Main Body Button Type		Mechanical button

