

## Buffalo Pro U7 Projector

# CONTENTS

YABER Lifetime Professional Support .....	01
TIPS .....	01
PACKAGE LIST .....	02
PROJECTOR SPECIFICATIONS .....	02
PROJECTOR OVERVIEW .....	03
REMOTE CONTROL .....	05
INSTALLATION .....	06
1.Installation Method .....	06
2.Projection Distance and Size .....	07
3.Install on the Ceiling .....	07
STARTING PROJECTOR .....	08
IMAGE ADJUSTMENT .....	08
1.Focus Adjustment .....	08
2.Digital 4D Keystone Correction .....	09
SETTING UP THE PROJECTOR .....	09
1.Select The Input Signal Source .....	09
2.USB Disk Insert Mode .....	10
3.WiFi Setting .....	13
3.1.iOS Cast(for iOS Devices) .....	14
3.2.Miracast(for Android Devices) .....	15
4.Bluetooth Setting .....	16
5.Projector Image Setting .....	16
5.1.Projection Mode .....	16
5.2.Keystone Advanced & 4-Point Keystone .....	17
5.3.Digital Zoom .....	19
6.System Update .....	19
7.Other Setting .....	20
8.About .....	21
SIGNAL LINES CONNECTION .....	21
1.Connect USB Disk .....	21
2.Connect the Devices via the HDMI ports .....	21
3.Connect to the DVD Player .....	21
4.Connect to the Soundbar/Speaker .....	21
SAFE SHUTDOWN .....	22
WARRANTY .....	22
TROUBLESHOOTING .....	23

## YABER Lifetime Professional Support

Dear customer,

Thank you very much for supporting YABER!

Please read this manual thoroughly before using the projector. If you have any issues, email your order number and the problem to

[aftersales@yabertech.com](mailto:aftersales@yabertech.com) We will provide a fast solution in 24 hours.

Actually, many problems can be easily solved by setting, such as no signal, no sound, bluetooth connection failed, WiFi connection failed, dark spots, choppy animation etc. We promise all the projectors have been 100% carefully checked and packaged before shipping.

If you have any questions, could you please contact us so that the problem can be solved. And give us an opportunity to improve. We guarantee we will provide you a satisfactory solution.

Thanks for your understanding!

YABER Service Team

### TIPS:

1. Do not place projector in too warm or too cold room, because the high temperature or low temperature will shorten lifespan of the device. The working environment would be 5°C~35°C better.
2. If there are black spots on the projection screen, please don't worry, please contact [aftersales@yabertech.com](mailto:aftersales@yabertech.com) via email, we can send you a video about how to remove the dust.
3. The ventilation is equipped for the projector to work stably. Don't cover the vent with cloth, blanket or other things. Don't insert anything into the slit of the projector, or it may produce a short circuit or an electric shock to your device and cause damage.
4. The projector shall be strictly protected from strong impact, extrusion and vibration. Do not try to move and on strong impact, extrusion and vibration. Do not try to move and the internal circuit faults.
5. Lens, as the core component of the projector, is directly related to the picture definition and effect. The excessive dust thereon will affect image quality. The dirty lens shall be wiped with soft cotton cloth for the glass lens surface. Hard cloth or abrasives shall not be used.

## PACKAGE LIST

Buffalo Pro U7 Projector*1	Remote Control*1	Power Cord*1
HDMI Cable*1	3-in-1 AV Cable	Lens Cover*1
Cleaning Kit*1	Quick Start Guide*1	Carry Bag*1

## PROJECTOR SPECIFICATIONS

Model No. Buffalo Pro U7			
Native Resolution	1920*1080P	Keystone Correction	Manual Vertical & Horizontal
Display Technology	LCD	Light Source	LED
Color Game	16.7M Full	Aspect Ratio	4:3/16:9
Recommended Projection Distance	4.0-22.3ft	Minimum Projection Distance	4.0ft
Power Voltage	AC100-240V	Projector Weight	4.8lb
Picture File	JPG/JPEG/ BMP/PNG	Interfaces	HDMI*2/USB*2/3.5mm Headphone jack/AV
Projection Method	Front/Rear on Desk, Front/ Rear on Ceiling		
Video File	3GP/ AVI/ MP4/ MPG/ MKV/ VOB/ TS/ MOV/ TRP		
Audio File	MP3/ AAC/ FLAC/ OGG/ WAV/ WMA		

# PROJECTOR OVERVIEW

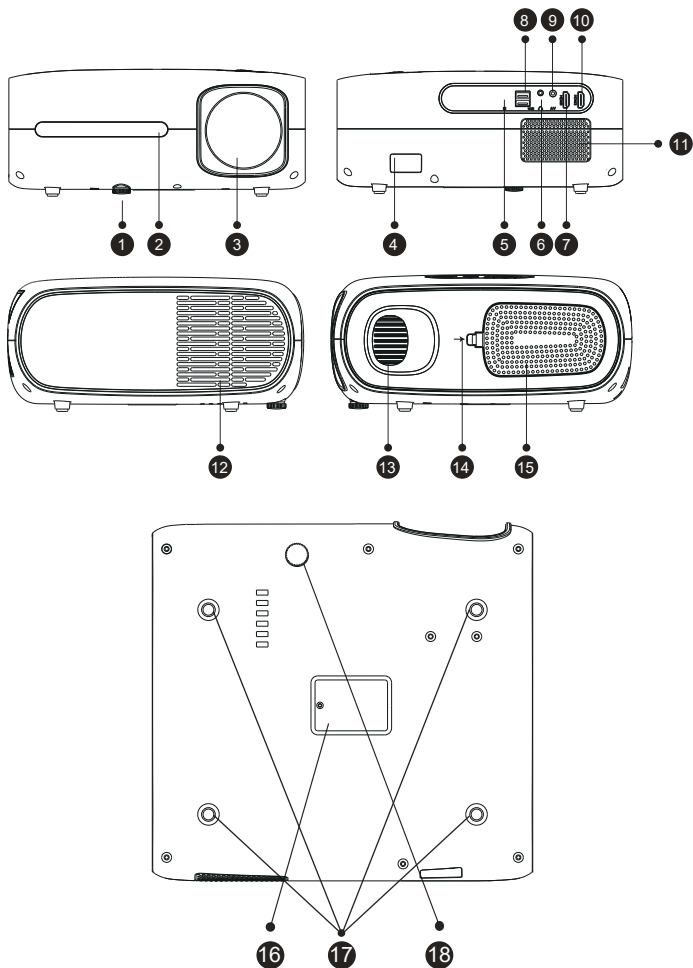

1/18	Height Adjustment Screw	Adjust the height of the projector
2/5	IR Window	Infrared signal receiver
3	Projector lens	Optical coated glass lens
4	Power Cord Port	Power Cord Port
6	Headphone Jack	3.5mm Headphone Output
7/10	HDMI Ports	HDMI 1 input / HDMI 2 input
8	USB Ports	USB 1 port / USB 2 port
9	AV Port	Audio input
11	Speaker	Stereo 5W
12	Air Outlet	Prevent the projector from overheating
13	Focus Ring	Adjust the focus ring to get the clearest image
14	Detachable Dust Filter Switch	Push the switch to open the detachable dust filter
15	Detachable Dust Filter/ Air Inlet	Prevent the projector's inside from the dust/ Circulate inside and outside air
16	Dust Cleaning Port	When black spots and dust appear on the screen, open the port to clean the dust
17	Rubber Pads	Protective pads/remove to install ceiling mount

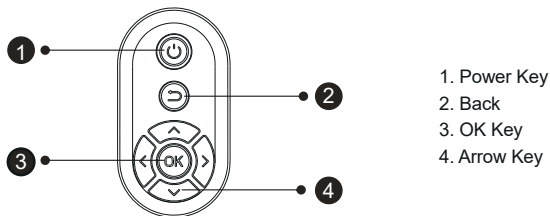

1	Power	Turn on/off the power
2	Back	Return to the previous menu
3	OK	Confirm the option
4	Arrow Keys	Used to adjust the parameter of the projector in the menu mode

## REMOTE CONTROL

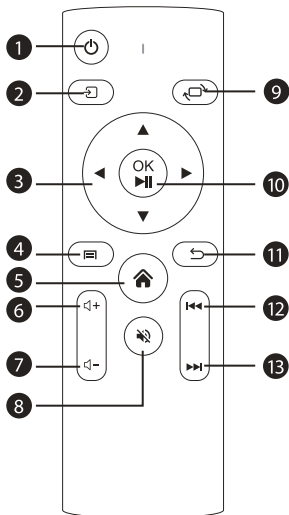

1. Power
2. Source
3. Arrow keys
4. Menu
5. Homepage
6. Volume +
7. Volume -
8. Mute
9. Picture flip
10. Confirmation key (Play and Pause)
11. Back
12. Previous
13. Next

1		Turn on/off the power
2		Select the input signal source
3		Used to adjust the parameter of the projector in the menu mode
4		Press once: Operate picture and sound settings in AV or HDMI Mode Press twice in succession: select 16:9/4:3 projection
5		Enter the home page
6		Volume up
7		Volume down
8		Close the sound
9		Picture flips
10		Confirm the option/Play or pause the video
11		Return to the previous menu
12		Switch to the previous video
13		Switch to the next video

## Note:

- 1). Install 2 pieces of AAA batteries into the remote controller before using it. Do not combine new batteries with old ones in remote controller, which can cause operation failure due to insufficient power supply.
- 2). When using the remote controller, please make sure that the signal transmitter of the remote controller aims at infrared signal receiver of the projector.
- 3). If you are not using the remote controller for an extended period, please take out batteries to prevent batteries leakage.

## INSTALLATION

### 1. Installation Method

The projector can be hung on the ceiling with special hanger frame, and placed on the stable desk to project the image according to the operating environment and requirements. In addition, the projector can be installed with following methods:

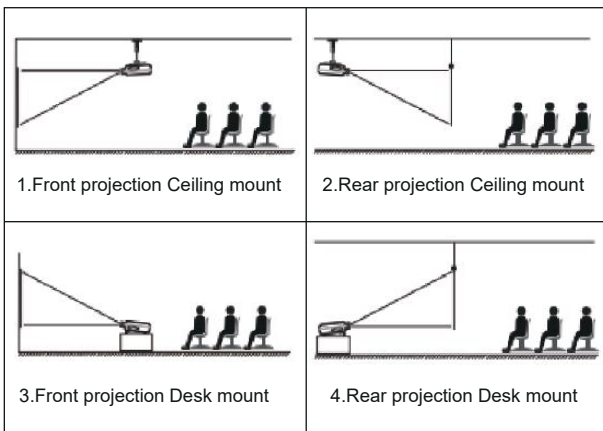

Keep the projector at a height where its lens is axial symmetry to the screen. If this is not possible, use the keystone correction function to adjust the projection image.

If you want to get a free projection screen, please contact us via [aftersales@yabertech.com](mailto:aftersales@yabertech.com)



Aspect Ratio: 16:9	
Distance (ft.)	Screen Size
4.0	35"
5.6	50"
7.7	70"
10.8	100"
13.1	120"
16.3	150"
22.3	200"

The recommended projection distance is about 10.8ft, the shortest projection distance is 4.0ft.

The image size depends on the distance between projector and screen, there may be 3% deviation among above listed data. Different settings cause various distances.

## 2. Install on the Ceiling

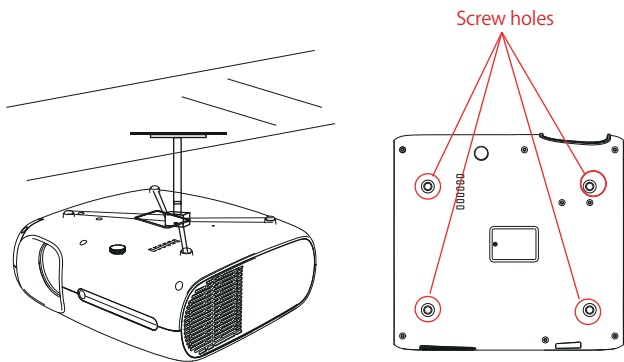

- A. Please purchase an universal projector ceiling mount;
- B. Remove the four rubber pads on the bottom of the projector, you will see the screw holes and use the M5\*11mm screws for installing the ceiling, and then install it.

## STARTING PROJECTOR

- 1) Press the power key on the remote controller or projector, the indicator light will turn blue;
- 2) Adjust the focus ring of the projector to get the best image performance; (If it is still blurry, please try to adjust the projection distance.)
- 3) Use the keystone function of the projector to get a rectangle projection screen;
- 4) Connect the external device (Smart phone, iPad, Fire TV, TV box, DVD player, Computer, etc.) in the corresponding interfaces of the projector, please be sure to select the corresponding source. If you do not select the correct source, the projector will not be able to detect the signal.;
- 5) Select the "  " menu, enter the [ Other Setting ], then you can select the option [ Language Setting ] to set your preferred language.

## IMAGE ADJUSTMENT

When using the projector for the first time, it normally displays an unclear image. This is due to the lens being out of focus or the incorrect trapezoid setting.

Please follow the below steps to correct:

### 1. Focus Adjustment

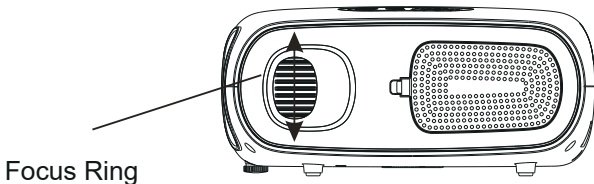

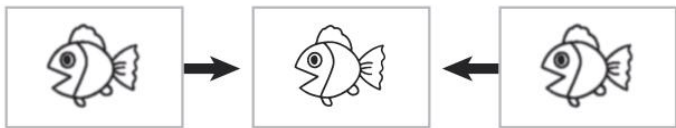

Rotate the focus ring or lens slowly. At the same time, check the focus point carefully. The best focus point for the lens would be where the image most clear.

Note: If it is still blurry, please try to adjust the projection distance.

## 2.Digital 4D Keystone Correction.

Use the digital 4D keystone correction of the projector to change the image to be rectangle(vertical and horizontal). Detail please refer the page 17 of this manual.

## SETTING UP THE PROJECTOR

The projector's home page is as follow.

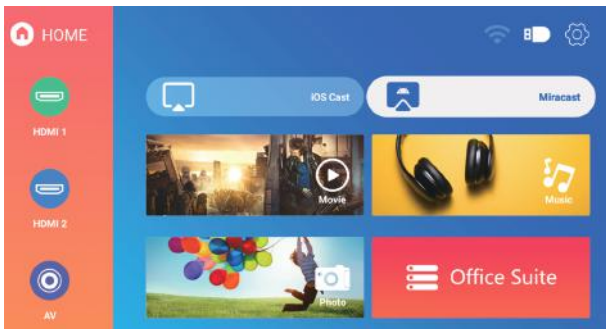

### 1. Select The Insert Signal Source

Select the desired insert signal source (HDMI1/HDMI2/AV) on the home-page

### 2. USB Disk Input Mode

2.1. Play Movie/Music/Photo/Office Suite in the USB Disk Insert Mode

- 1). Insert the USB Disk, the [USB] icon of the homepage will turn white.
- 2). Select the option [ Movie/Music/Photo/Office Suite].
- 3). Select the desired file (or folder to enter the subfolder) in the USB disk, then press the [ OK ] button to play it.

#### External Device



PS:

- a. Buffalo Pro U7 upgraded projector supports U disk to directly play PPT, Word, Excel files.
- b. If you enter from the [Movie] menu, you can only play the video, The same as other 3 options.

## 2.2.Play Interface



Menu	Function
	Select play mode (directory play/single cycle/directory loop)
	Switch to the previous video
	Fast Backward,rewinds the video back quickly while playing it. The rewinding speed ranges from 2X to 32X
	Play or pause the current video
	Fast Forward, pushes the video to move forward quickly while playing it. The forward speed ranges from 2X to 32X
	Switch to the next video
	Select all playlists in the current folder
	Playing settings

Playing settings	Include	Function
Video subtitle	close,inner,external	Set multiple modes of video subtitles
Breakpoint play	close,open	You can set the video continue to play from the point where it was stopped
Audio track	Audio track	You can see the audio information
Display mode	16:9,full,over,auto,4:3	You can set the video aspect ratio
Picture settings	Picture Mode, Color Temperature, Reset to Default	You can set the picture information
Sound settings	Sound Style, Equalizer Detail, Reset to Default	You can set the sound information

Menu	Content	Mode	Function
Picture Mode	User/Standard/Vivid/ Sport/Movie/Game/ Energy Saving	Brightness	Modify the picture parameters in the range 0-100
		Contrast	
		Saturation	
		Sharpness	
Sound Style	User/Standard/Vivid/ Sports/Movie/Music/News	Balance	Modify the sound parameters in the range 0-100
		Bass	
		Treble	



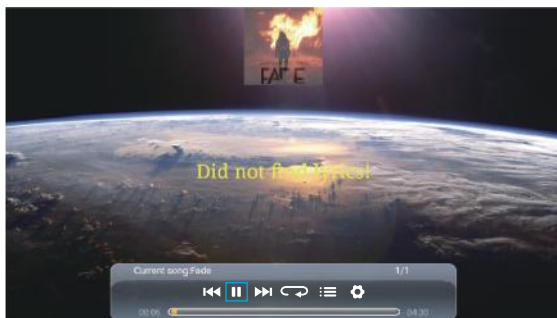



### 2.3.Music Play Interface

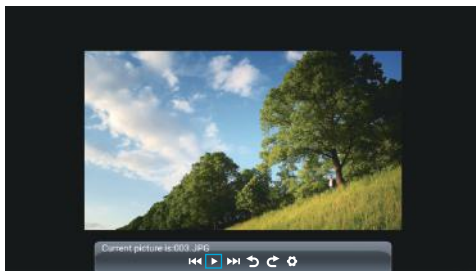

Menu	Function
⏮	Switch to the previous music.
⏸	Play or pause the current music.
⏭	Switch to the next music.
🔄	Repeat the music.
☰	Select the music list.
⚙️	Set the sound information.

## 2.4. Picture Play Interface



Menu	Function
	Switch to the previous picture.
	Pause the auto - play mode of a picture.
	Switch to the next picture.
	Flip picture 90° to the left.
	Flip picture 90° to the right.
	Set the picture information.

## 3. WiFi Setting

### Wireless Connection

#### Warming Tips:

- ① The fluency of screen mirroring with wireless connection will be affected by the network environment. A bandwidth of 100Mbit or more is recommended when using screen mirroring.
- ② Make sure your mobile device is close to the projector when using wireless connection. A distance within 1 meter is recommended.
- ③ Some mobile devices may not support screen mirroring due to the compatibility.
- ④ Any questions, please feel free to email YABER via [aftersales@yabertech.com](mailto:aftersales@yabertech.com)

### 3.1.iOS Cast (for iOS Devices)

1.Go to home page -- Select the [  ] menu -- Select the [ WiFi Setting ] menu -- Open the WiFi function -- Select your home WiFi from the list -- Connect the Buffalo Pro U7 projector to your home WiFi.



2.Back to home page -- Select [ iOS Cast ] menu -- Press the OK button to enter the [ iOS Cast ] menu.

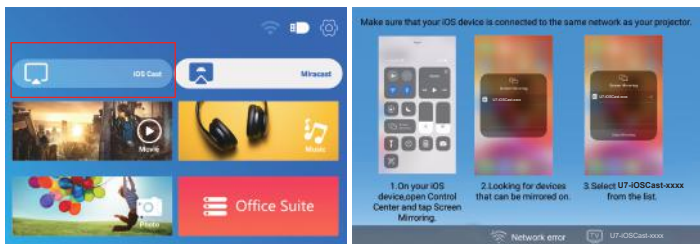

3.Select the [ Settings ] menu on your iOS device -- Turn on the [ Wi-Fi ] function -- Connect your iOS device to the same home network as the projector.

4.Open the [ Control Center ] on your iOS device -- Select the [ Screen Mirroring ] function -- Select and connect the iOS Cast receiver named [ U7-iOSCast-xxxx ] -- your iOS device screen will be displayed on the projection screen after 3 seconds.



## 3.2.Miracast (for Android Devices)

1.Go to home page -- Select the [ Miracast ] menu -- Press the OK button to enter the [ Miracast ] interface.

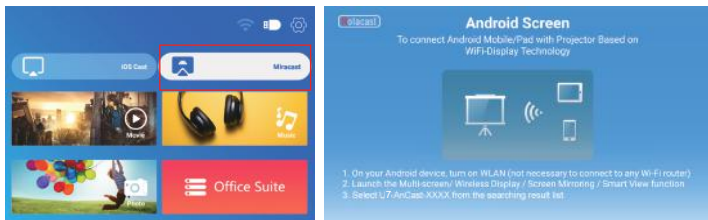

2.Select the [ Settings ] menu on your Android device -- Select the [ Screen mirroring ] function -- Select your Miracast receiver named [ U7-AnCast-XX ] -- your Android device screen will be displayed on the projection screen after 3 seconds.

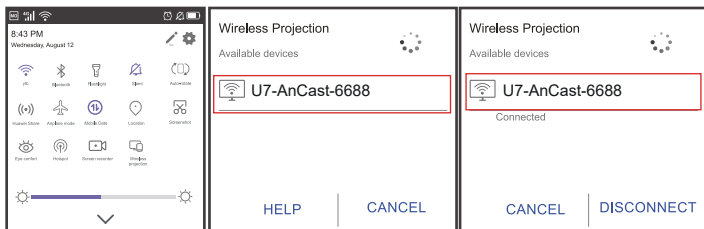

3.On your Android device, tap [ Settings ]-[ WLAN Display ] -Turn [ Wi-Fi ] ON, Connect your home WiFi.

### Note:

1.Different brands of Android phones have different operations for select Screen Mirroring Display, please refer to your phone's manual. [ Multiscreen/Wireless display/WLAN display/Screen mirroring/Wireless projection/Smart view etc. ]

2.Not all Android phones support this function. Please make sure it is supported before use.

## 4. Bluetooth Setting

Go to home page -- Select the [  ] menu -- Select the [ Bluetooth Setting ] Option -- Open the Bluetooth function and your Bluetooth device -- Scan the Bluetooth devices nearby automatically -- Choose the Bluetooth device desired -- it will be paired and connected automatically.

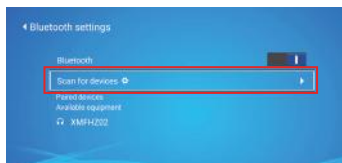
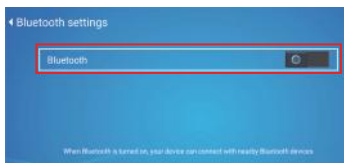
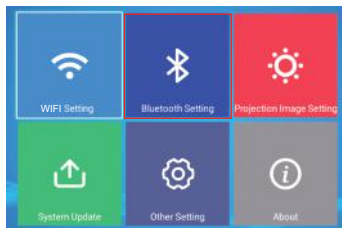

### Note:

1. The Buffalo Pro U7 projector is compatible with the Bluetooth headsets, Bluetooth speakers and Airpods, but not the Bluetooth keyboards or Bluetooth phones. 2. If you have any question, please feel free to email YABER via: [aftersales@yabertech.com](mailto:aftersales@yabertech.com)

## 5. Projector Image Setting

### 5.1. Projection Mode

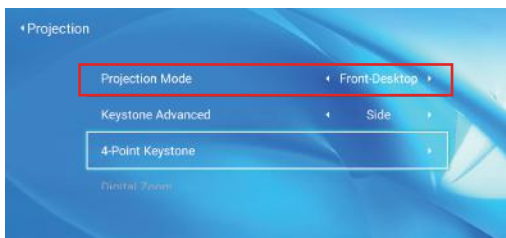

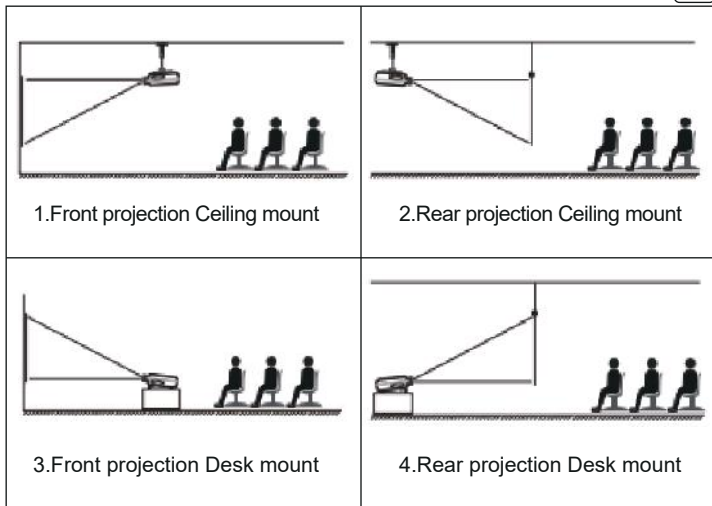

## 5.2. Keystone Advanced & 4-Point Keystone

### 5.2.1. Vertical Keystone Correction

Step 1: Select the [ Front ] option in the [ Keystone Advanced ] menu, then press the ▼ button to enter the [ Manual Keystone ] menu.



Step 2: If the projection image shows as (1), press the button on the remote controller or projector to increase the vertical parameter (-50~0), until to achieve the projection image (2).

Step 3: If the projection image shows as (3), then press the button on the remote controller or projector, and decrease the vertical parameter (0~50), until to achieve the projection image (4).



### 5.2.2. Horizontal & Vertical Keystone Correction

When the projection screen is not rectangular, it can be adjusted by 4-point keystone correction.

Step 1: Select the [ Side ] option in the [ Keystone Advanced ] menu.

Step 2: Press the button to select the [ 4-Point Keystone ] menu, then press the [ OK ] button to enter the submenu.

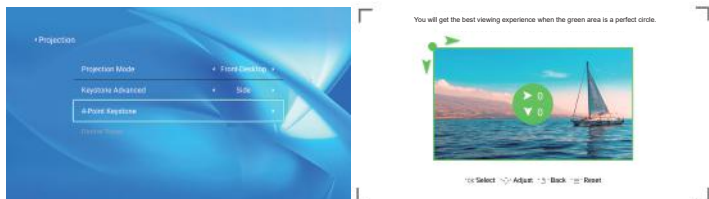

Step 3: Keep pressing the OK button on the remote controller or projector to select the point .

Step 4: Press the arrow keys on the remote controller or projector to adjust the horizontal or vertical parameters, until the projection screen becomes the desired rectangle.

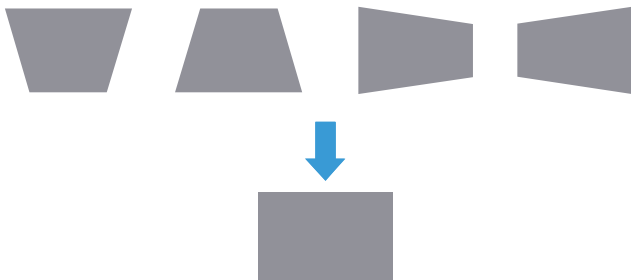

**OK Pick point** :Keep pressing the OK button on the remote controller or projector, until the positioning icon  appears at the point desired, then release the button immediately.

**↔ Adjustment** :Press the arrow keys on the remote controller or projector to adjust the horizontal or vertical parameters.

**↶ Back** : Press the key on the remote controller to back to previous page.

**☰ Reset** :Press the  key on the remote controller to restore the original parameters.

### 5.3.Digital Zoom

Step 1: Select the [ Digital Zoom ] option and press the OK button on the remote controller or projector to enter the submenu.

Step 2: By pressing the  button on the remote controller or projector, you can reduce the height and width of projection size up to 50%.

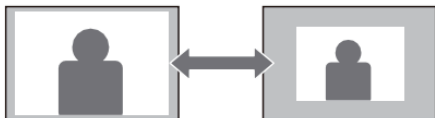
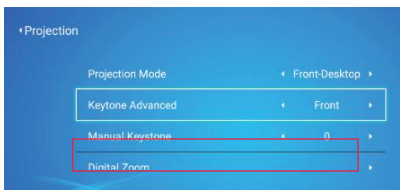

## 6.System Update

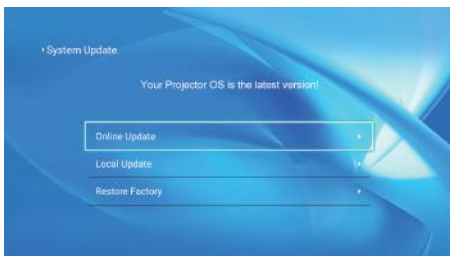

Menu	Function
Online Update	Online update
Local Update	Local update
Restore Factory	Restore user operation application configuration and system setting

## 7.Other Setting



Menu	Function
Boot Source Option	Off/HDMI1/HDMI2/AV
Power On Option	Direct/Standby
Language Setting	Set up the language
Scheduled Shutdown	Off/10min/20min/30min/60min/120min

### About the Direct/Standby Power On Option

**Direct Mode:** When the projector is powered on, the projector will be automatically turned on.

**Standby Mode:** When the projector is powered on, you need to press the  button on the remote controller or projector to turn on the projector.

## 8.About

Menu	Content
System Version	V1.0.0.2:2022-XX-XX
MAC Address	Ac:5d:5c:c5:d9:83

## SIGNAL LINES CONNECTION

Buffalo Pro U7 projector has 6 interfaces, HDMI ports\*2/ USB ports\*2/ 3.5mm headphone output/ AV in. Please select the correct connecting port to connect your device (PC, Phone, DVD Player, Sound bar, USB, PS4 etc.)

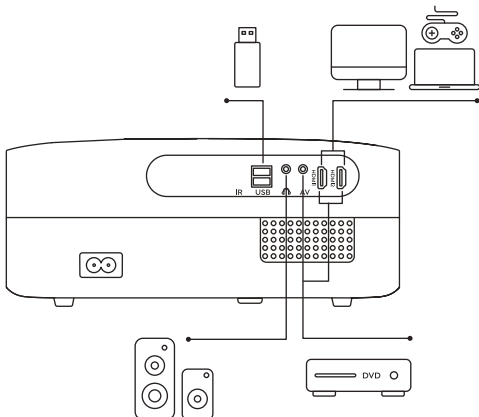

### 1.Connect USB Disk

- 1) Insert the U disk into either of the two usb input ports;
- 2) You can directly enter the start-up screen on the home page, select the option [ Movie/Music/Photo/Office Suite]
- 3) Select the desired file (or enter the subfolder) in the USB disk, then press the [ OK ] button to play it.

### 2.Connect the Devices via the HDMI ports

- 1) Connect your TV stick or laptop to any HDMI port of the projector;
- 2) Enter the home page to select the corresponding HDMI1 or HDMI2 as the signal source.

### 3.Connect to the DVD Player

Use the 3-in -1 AV cable in the package

- 1) Turn on your DVD player and the projector;
- 2) Connect the colorful female connectors to your DVD player's RCA cable with the 3-in-1 AV cable in the package;
- 3) Connect the black connector to the AV port of the projector, enter the home page to select [ AV ] as the signal source.

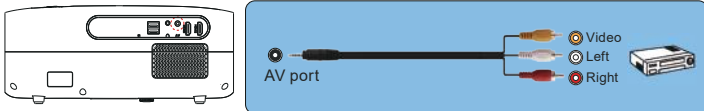

Or connect to the DVD Player with the HDMI cable in the package.

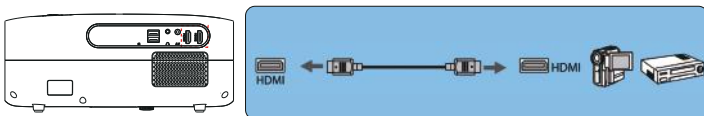

### 4.Connect to the Sound bar/Speaker

If your speaker has AUX port, please use your 3.5mm audio cable connect the projector and your speaker as the picture shows, enter the home page to select [ AV ] as the signal source.

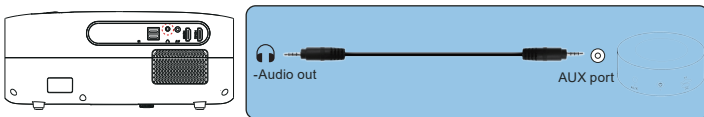

## SAFE SHUTDOWN

- 1.Press the  button on the projector or remote controller,then press OK key to power off the projector.
- 2.Unplug the power cord of the projector.
- 3.Cover the lens and store the projector in a cool and dry place.

## WARRANTY

Thank you so much for your purchase and support! We provide 3-year warranty for Buffalo Pro U7 projector. If you have any questions, please feel free to contact us via [aftersales@yabertech.com](mailto:aftersales@yabertech.com).



## TROUBLESHOOTING

---

Problems listed below might occur during the operation of your projector. Please refer to the possible factors which might cause the issue to do troubleshooting.

### **1. When turning on the power switch, the indicator light does not work.**

- 1) The power might not be connected well.
- 2) Check the over-heat protection system.

### **2. The remote controller does not communicate with the projector.**

- 1) The power switch at the back of the projector is turned on or off?
- 2) The remote controller's batteries are depleted?
- 3) Something obstructing the signal between the remote and IR
- 4) Strong light on IR directly.

### **3. No image on the screen.**

- 1) Is the channel set-up correct?
- 2) Is there an input signal ?
- 3) Is the input cable plugged well ?
- 4) Under PC mode, is the refresh rate > 75KHz ?

### **4. Blue screen,no picture,no sound.**

Input cables connected right?

### **5. Picture right, no sound.**

- 1) Input cables connected right?
- 2) Volume at min or on Mute.

### **6. Can't play the movies.**

- 1) The format of the video is right?
- 2) Files are broken?
- 3) Device is broken?

### **7. There is picture, no sound?**

The decode system doesn't match.

### **8. Can't find devices when connected with hard drive or flash drive.**

Check if the device is broken.

### **9. Auto-off after working for a while.**

- 1) The projector ventilation is blocked.
- 2) The over-heat protection system.

FCC ID:2A4K9-PROU6

## **FCC STATEMENT :**

**This device complies with Part 15 of the FCC Rules. Operation is subject to the following two conditions:**

- 1) This device may not cause harmful interference, and
- 2) This device must accept any interference received, including interference that may cause undesired operation.

**Warning:** Changes or modifications not expressly approved by the party responsible for compliance could void the user's authority to operate the equipment.

**NOTE:** This equipment has been tested and found to comply with the limits for a Class B digital device, pursuant to Part 15 of the FCC Rules. These limits are designed to provide reasonable protection against harmful interference in a residential installation. This equipment generates uses and can radiate radio frequency energy and, if not installed and used in accordance with the instructions, may cause harmful interference to radio communications. However, there is no guarantee that interference will not occur in a particular installation. If this equipment does cause harmful interference to radio or television reception, which can be determined by turning the equipment off and on, the user is encouraged to try to correct the interference by one or more of the following measures:

Reorient or relocate the receiving antenna.

Increase the separation between the equipment and receiver.

Connect the equipment into an outlet on a circuit different from that to which the receiver is connected.

Consult the dealer or an experienced radio/TV technician for help.

## **FCC Radiation Exposure Statement:**

This equipment complies with FCC radiation exposure limits set forth for an uncontrolled environment. This equipment should be installed and operated with minimum distance 20cm between the radiator & your body.

## **WARRANTY AND SERVICE**

**We guarantee the unit TO BE free from defects in material or workmanship for a period of one (1) year from the date of purchase.**

Should this unit be operated under conditions other than those recommended or at voltages other than the voltage indicated on the unit, or any attempts made to service or modify the unit, this will render WARRANTY VOID. The product you buy may sometimes differ slightly from illustration.



#### **DISPOSAL:**

This marking indicates that this product should not be disposed with other household wastes throughout the EU. To prevent possible harm to the environment or human health from uncontrolled waste disposal, recycle it responsibly to promote the sustainable reuse of material resources. To return your used device, please use the return and collection systems or contact the retailer where the product was purchased. They can take this product for environmental safe recycling.

## Declaration of Conformity

We (Manufacturer is responsible for this declaration)

YABER TECHNOLOGIES CO.,LIMITED.

(Company name)

Room 406,4 Floor,B Building,BanTian International Center,HuanCheng  
South Road,BanTian Street, LongGang District,Shenzhen, China

(Company address)

declare under our sole responsibility that the product

Trade name: Yaber

Equipment: Entertainment Projector

Model No. : Buffalo Pro U7

to which this declaration relates is in conformity with the essential  
requirement set out in the Council Directive on the Approximation of the  
laws of the Member States relating to LVD Directive(2014/35/EU) &  
EMC Directive(2014/30/EU) & RoHS(2011/65/EU) product is responsi-  
ble to affix CE marking, the following standards were applied:

EN 62368-1:2014+A11:2017

EN IEC 62311:2020

ETSI EN 301 489-1 V2.2.3(2019-11)

ETSI EN 301 489-17 V3.2.4(2020-09)

ETSI EN 301 489-3 V2.1.1(2019-03)

EN 55032:2015+A11:2020

EN 55035:2017 +A11:2020

EN IEC 61000-3-2:2019

EN 61000-3-3:2013+A1:2019

ETSI EN 300 328 V2.2.2(2019-07)

ETSI EN 301 893 V2.1.1(2017-05)

ETSI EN 300 440 V2.2.1(2018-07)

IEC62321-3-1:2013

IEC62321-4:2013

IEC62321-5:2013

IEC62321-6:2015

IEC62321-7-1:2015

IEC62321-7-2:2017

IEC62321-8:2017

Full Name: George.wang      Position: Approbation Manager

Signature: George.wang      Place/Date: Shenzhen,China/Mar.04-2022



 [www.yabertech.com](http://www.yabertech.com)

 [aftersales@yabertech.com](mailto:aftersales@yabertech.com)

 @Yaber Entertainment Projector

 @Yaber Entertainment Projector